

A B C E



# Standard Centrifugal Pump

## Model VGH5C31-B

### Size 6" x 5"

#### PUMP SPECIFICATIONS

**Size:** 6" x 5" (152 mm x 127 mm) Raised Face Flanges.

**Casing:** Ductile Iron.

Maximum Operating Pressure 182 psi (1255 kPa).\*

**Enclosed Type, Six Vane Impeller:** Gray Iron 40.

Handles 25/32" (20 mm) Diameter Spherical Solids.

**Impeller Shaft:** Steel 1045.

**Two Replaceable Wear Rings:** Gray Iron 25.

**Seal Plate:** Ductile Iron.

**Bypass Flush Piping.**

**Bearing Housing:** Gray Iron 25.

**Radial Bearing:** Open Cylindrical Roller.

**Thrust Bearing:** Open Double Row Ball.

**Bearing Lubrication:** SAE 30 Non-Detergent Oil.

**Gaskets:** Nitrile Rubber.

**Hardware:** Standard Plated Steel.

**Bearing Housing Level Oiler.**

**Optional Equipment:** Strainer. NPT Suction and Discharge Flanges. Discharge Check Valve. Consult Factory for Optional Seals.



*\*Consult Factory for Applications Exceeding Maximum Pressure and/or Temperature Indicated.*

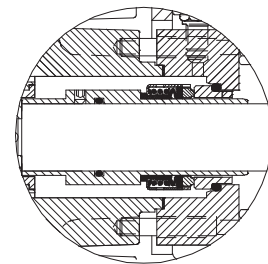
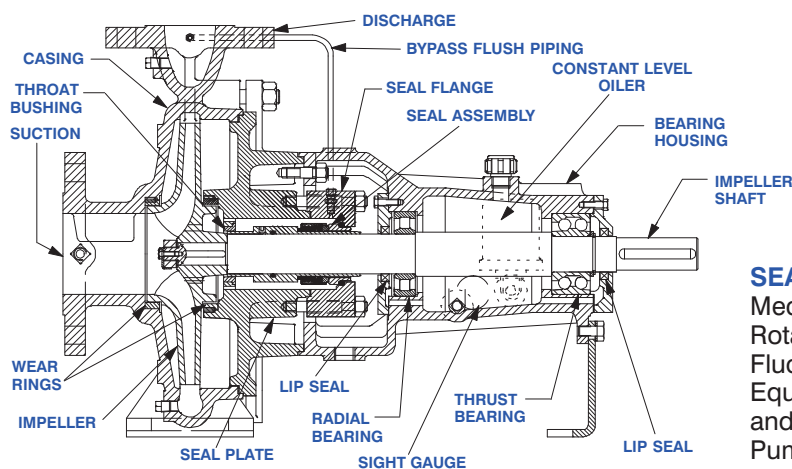

#### SEAL DETAIL

Mechanical, Self-Lubricated. Silicon Carbide Rotating and Stationary Faces. Fluorocarbon Elastomers (DuPont Viton® or Equivalent). Stainless Steel 316 Shaft Sleeve and Spring. Maximum Temperature of Liquid Pumped, 160°F (71°C).\*



THE GORMAN-RUPP COMPANY • MANSFIELD, OHIO

GORMAN-RUPP OF CANADA LIMITED • ST. THOMAS, ONTARIO, CANADA

www.grpumps.com

Specifications Subject to Change Without Notice

Printed in U.S.A.

**Specification Data**

SECTION 70, PAGE 1026

APPROXIMATE  
DIMENSIONS and WEIGHTS

**NET WEIGHT: 419 LBS. (190 KG.)**  
**SHIPPING WEIGHT: 490 LBS. (222 KG.)**  
**EXPORT CRATE SIZE: 17 CU. FT. (0,5 CU. M.)**

DISCHARGE:  
.88/[22,4] DIA. 8 HOLES EQUALLY SPACED ON A  
8.50/[216,0] DIA. B.C. OR OPTIONAL 5.00-8 NPT  
COMPANION FLANGE

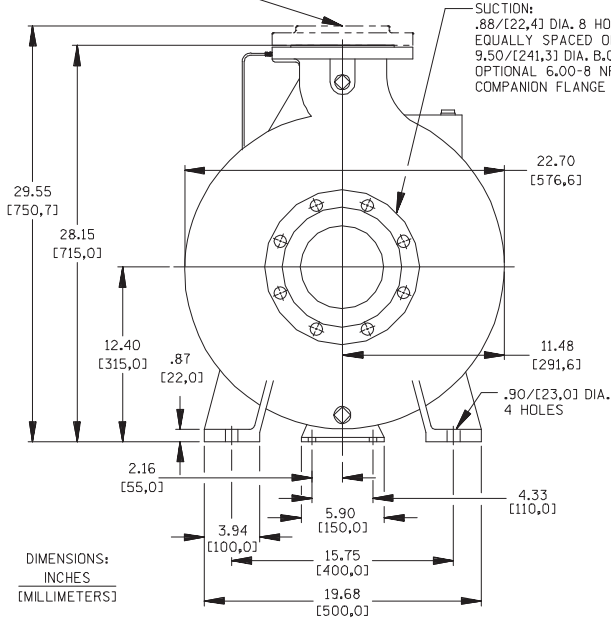

SUCTION:  
.88/[22,4] DIA. 8 HOLES  
EQUALLY SPACED ON A  
9.50/[241,3] DIA. B.C. OR  
OPTIONAL 6.00-8 NPT  
COMPANION FLANGE

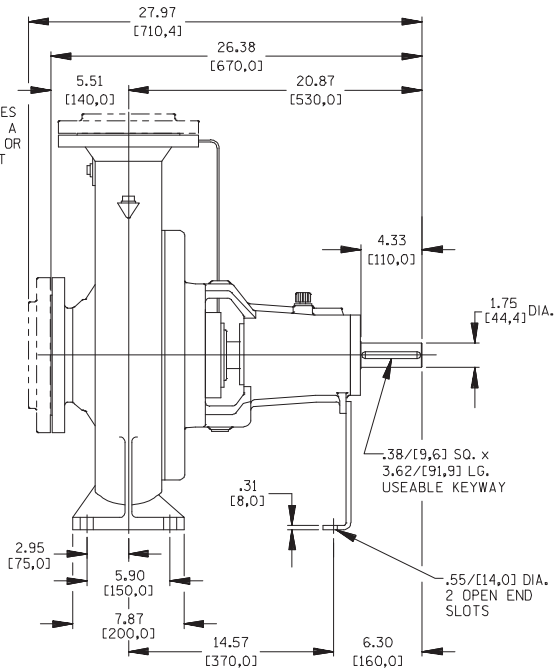

**Pump Performance Specifications**

Pump Model	Size	Capacity	Total Head
VGH5C31-B~	6" × 5" (152mm × 127mm)	5m <sup>3</sup> /min	60m
Speed	Imp. Dia	SP.GR	Max Temp
1750rpm	15"	1.0	71°C(160°F)



THE GORMAN-RUPP COMPANY • MANSFIELD, OHIO

GORMAN-RUPP OF CANADA LIMITED • ST. THOMAS, ONTARIO, CANADA

Specifications Subject to Change Without Notice

Printed in U.S.A.

Curve Data

Sec. 70

PAGE 1026.1  
NOVEMBER 2007

A B C E

PERFORMANCE  
BASED ON  
WATER

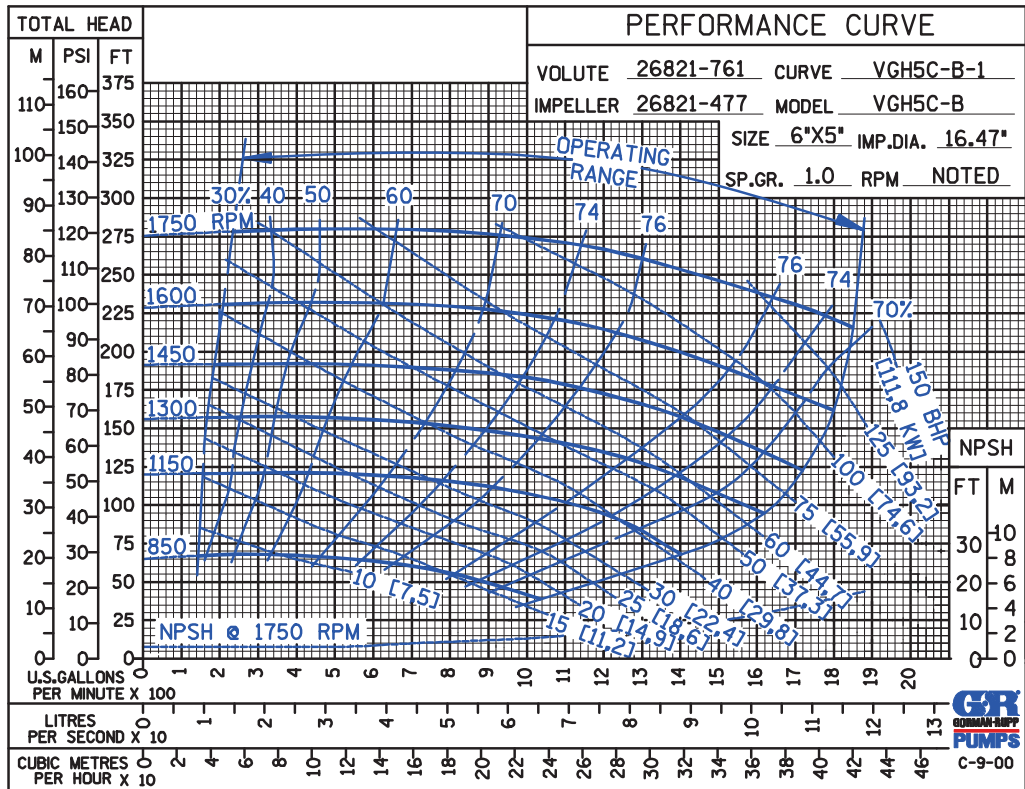

PERFORMANCE  
BASED ON  
WATER

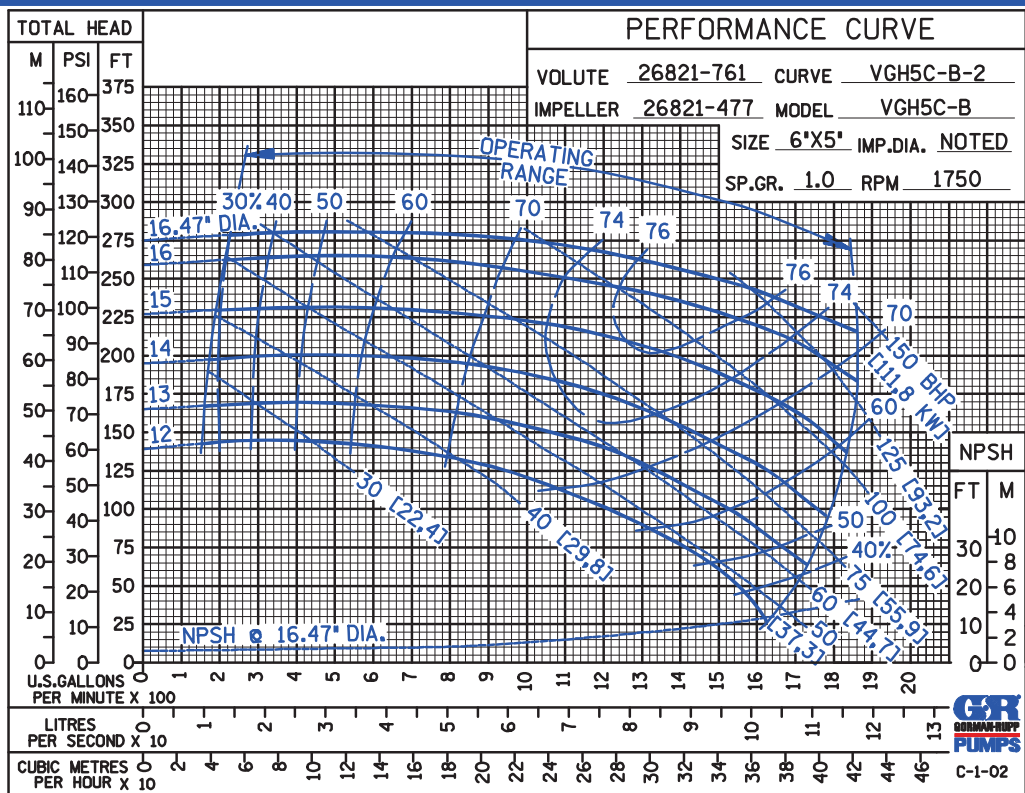

THE GORMAN-RUPP COMPANY • MANSFIELD, OHIO

GORMAN-RUPP OF CANADA LIMITED • ST. THOMAS, ONTARIO, CANADA

Specifications Subject to Change Without Notice

Printed in U.S.A.

ABCE

PERFORMANCE  
BASED ON  
WATER

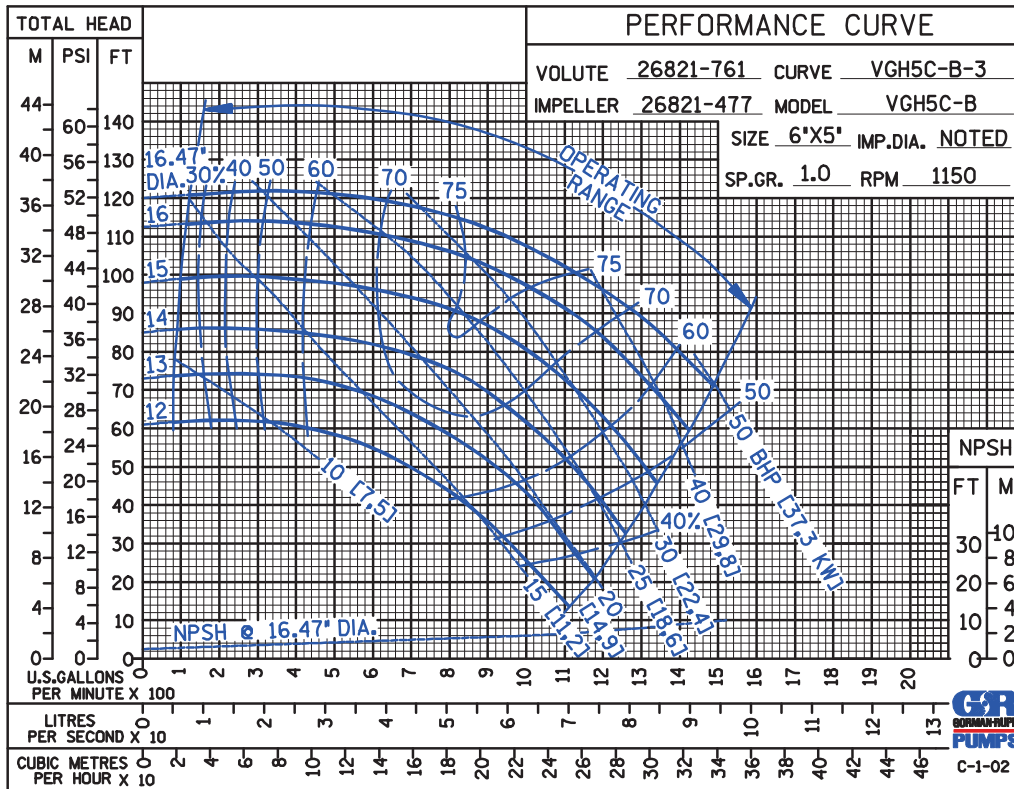

PERFORMANCE  
BASED ON  
WATER

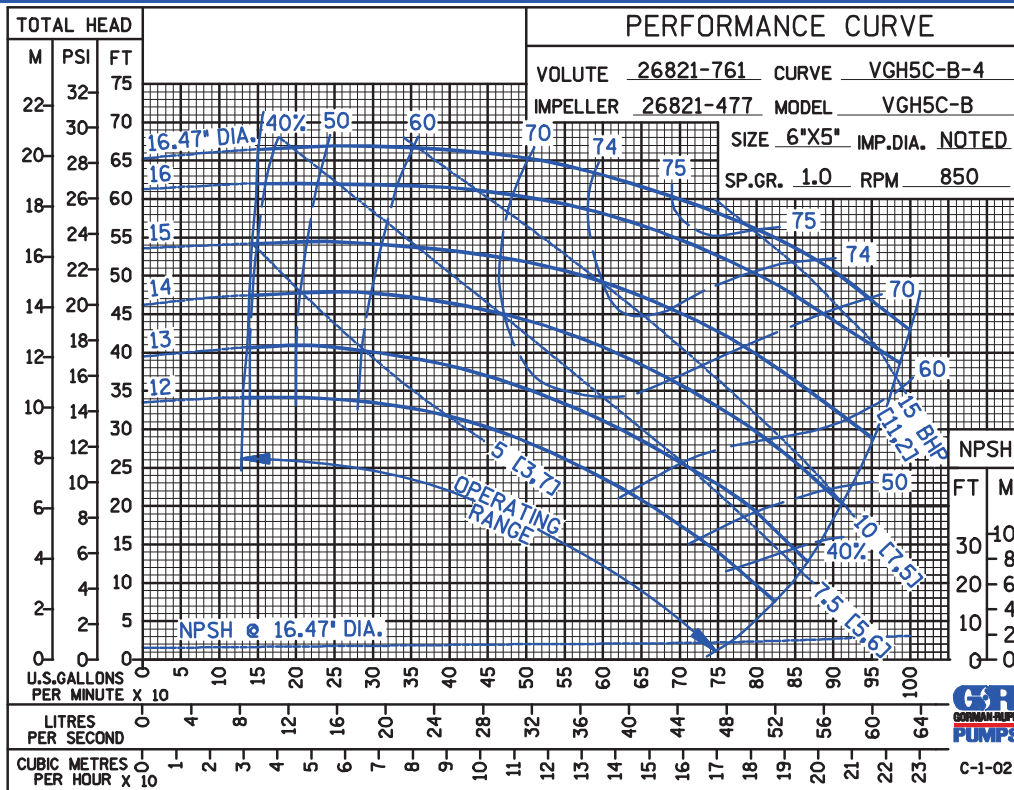

THE GORMAN-RUPP COMPANY • MANSFIELD, OHIO

GORMAN-RUPP OF CANADA LIMITED • ST. THOMAS, ONTARIO, CANADA

Specifications Subject to Change Without Notice

Printed in U.S.A.

ABCE

PERFORMANCE  
BASED ON  
PETROLEUM

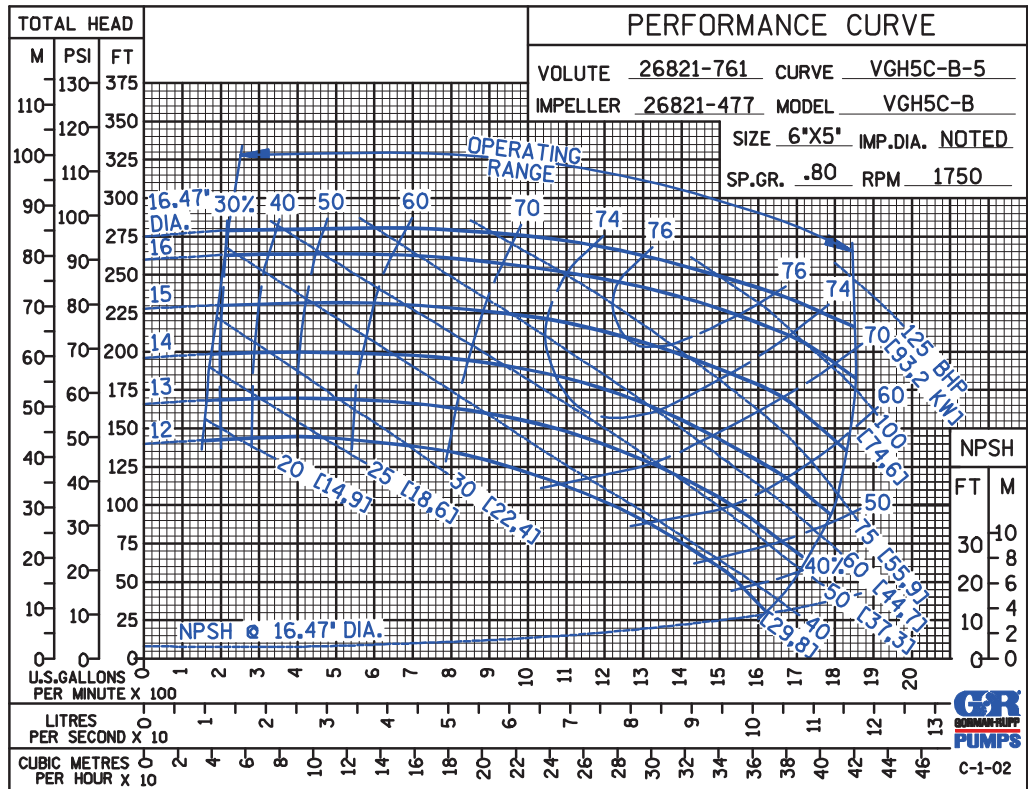

THE GORMAN-RUPP COMPANY • MANSFIELD, OHIO

GORMAN-RUPP OF CANADA LIMITED • ST. THOMAS, ONTARIO, CANADA

Specifications Subject to Change Without Notice

Printed in U.S.A.